

design brief

ECONOMIZERS

Summary

An air-side economizer is an HVAC control system that can provide significant cooling energy savings when properly specified, installed, commissioned, and maintained. Unfortunately, the economizer's collection of dampers, actuators, linkages, sensors, and controllers rarely achieves its savings potential. Estimates indicate that only about one in four economizers works properly, with the remaining three providing sub-par performance or, worse yet, wasting prodigious amounts of energy. Failures are a result of maintenance deficiencies, improper control, or systemic problems. A healthy economizer begins life with a good design concept, careful specification of its constituent components, and performance testing of its operation under a variety of conditions. As time passes, it is important to retest the system periodically. Although advances in computer-based diagnostics can help identify malfunctioning systems, the human element is still essential to maintaining these systems.

Economizers rarely save as much as they should and some waste a lot of energy. Better design, controls, installation, monitoring, and maintenance can help economizers meet their potential.

CONTENTS

Introduction	2
The Pathology of Economizer Failure	6
How to Specify Economizers to Prevent Component Failures	13
Making Sure Your Economizer Works Right from the Start and Keeps on Working	19
When Not to Use Economizers	24
Conclusion	25
Notes	26

Evidence is rolling in that most economizers do not work properly and that many are energy wasters, not energy savers.

Introduction

Economizers save energy by using outside air to cool buildings. They are ubiquitous in the U.S., especially in California, where they are required by state regulations for most medium to large cooling systems. Although they are based on a relatively simple operating concept (see sidebar, *What Is an Economizer? How Does It Work?*), evidence is rolling in that most economizers do not work properly and that many are energy wasters, not energy savers. We can't say with any certainty how much energy overall is wasted by malfunctioning economizers, but the potential is high. For example, in hot inland regions such as California's Central Valley, a worst-case scenario is that a failed economizer might cause total annual electric consumption to increase nearly 50 percent, whereas, if it had worked as intended, it might have saved 5 percent of annual building electrical consumption.¹

The potential for energy waste is impressive when one considers how many economizers are out there. A 2003 survey of commercial buildings in the U.S. shows that about 508,000 buildings have economizers assisting HVAC systems that condition more than 21 billion square feet of building space.² One reason so many U.S. buildings have economizers is that most state energy codes require them. National professional standards require economizers for most medium to large cooling systems. Because many states modeled their energy codes on these standards, they have the same requirement.

Definitions

Drybulb temperature. Air temperature as measured by a standard thermometer, which does not take humidity into account.

Enthalpy. A measure of the energy content of air that includes both drybulb temperature and humidity.

High-limit temperature. The user-specified temperature above which the economizer cannot help meet the building's cooling load. When the outdoor temperature is above the high limit, the outside-air damper is

set to minimum and compressors are used to cool the building.

Lockout temperature. The user-specified temperature below which the economizer should not be used because the building does not require cooling. The setting not only helps achieve energy savings, but also prevents chilled water coil freeze-ups in built-up systems and compressor problems caused by low loads in packaged rooftop units. When the outdoor temperature is below the lockout setting, the outside-air damper is closed and the compressors are turned off.

WHAT IS AN ECONOMIZER? HOW DOES IT WORK?

Economizers draw cool outside air into buildings to reduce use of expensive mechanical cooling systems. They typically save about 20 to 30 percent of overall cooling energy consumption. In their most basic form, economizers include the following components (see Figure 1 for each component's location):

- **Outside-air damper.** Regulates how much outside air is introduced into the building.
- **Return-air damper.** Regulates how much return air is recirculated back into the building.
- **Exhaust-air damper.** Regulates how much return air is exhausted from the building.
- **Outdoor temperature sensor.** Measures the temperature of air outside of the building.
- **Economizer logic controller.** Receives a signal from the outside-air temperature sensor, and in turn decides if the outside-air damper should be opened or closed.

- **Actuator.** Changes the position of a damper based on a signal received from the logic controller.

- **Linkage.** Connects an actuator to a damper.

When the economizer logic controller determines that the outside-air temperature (or enthalpy, in some cases—see Definitions on page 2) is low enough to meet some or all of the cooling load, the outside-air damper is completely opened and the air conditioning compressors are turned off. An exhaust fan runs when the economizer is operating to help remove air from the building. When the outdoor temperature becomes too high to provide useful cooling, the outside-air damper moves to a minimum position (based on minimum ventilation requirements for the building), the return opens and exhaust closes, and compressors are operated to cool the building. Some economizers, known as integrated economizers, are capable of combining both outside air and compressor cooling to maintain comfort conditions, but this is a significantly more complex operation, as described on page 17.

Figure 1: The components of an economizer

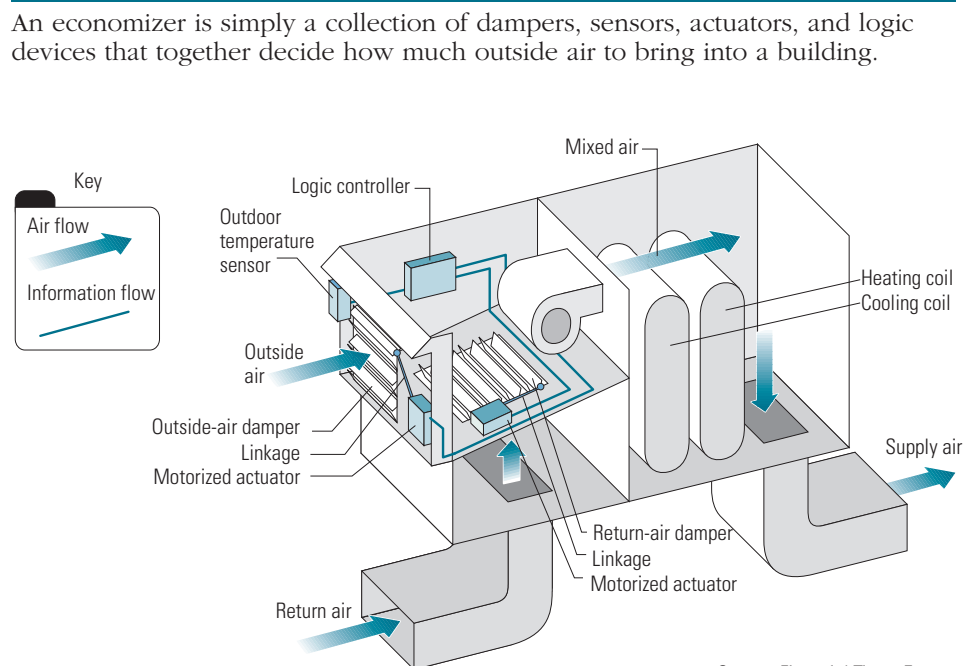

Source: Financial Times Energy

Title 24

Title 24 2008³ includes requirements for economizer design, controls and testing in California's non-residential buildings. Though the list included below is not intended to be comprehensive, it does illustrate the primary compliance requirements included in the code.

- Under the prescriptive compliance approach, fully integrated economizers are required for all space cooling systems that have a design capacity over 2,500 cfm for supply and a total cooling capacity over 75,000 Btu/h unless the project meets one of the exceptions stated in the code.
- Economizers are not required when unitary air-conditioners or heat pumps have a rated efficiency meeting or exceeding minimum levels specified in Table 144-A of the Title 24 2008 Standard (if using the prescriptive compliance approach).
- If an economizer is required by code, it must be designed and the control sequence must be specified such that building heating energy use during normal operations does not increase.
- Economizer controls must be fully integrated with cooling system controls in order to provide partial cooling even when mechanical cooling is required to meet the remaining load. Packaged units with stand alone economizers must have a two stage thermostat to meet this requirement.
- Non integrated economizers cannot be used to meet the economizer requirements of the prescriptive compliance approach, but may be used if they comply through the performance compliance approach.
- Air side economizers are required to have high-limit shut off controls.
- All new economizers must meet the Acceptance Requirements (i.e. acceptance testing) outlined in the Standard for code compliance before a final occupancy permit is granted.

The flowchart diagrammed in Figure 2 has been included in Title 24 2008 to help designers determine if economizers are required when using the prescriptive compliance approach.

Source: Title 24 2008 Nonresidential Compliance Manual

Although it is not known with much certainty how many economizers are malfunctioning, at least one major research laboratory is on the case. Pacific Northwest National Laboratory (PNNL) has evaluated economizer operation in a wide variety of U.S. commercial buildings. The findings suggest that malfunctioning economizers are a significant problem. For example, the lab monitored six out of forty

FIGURE 2: TITLE 24 FLOWCHART

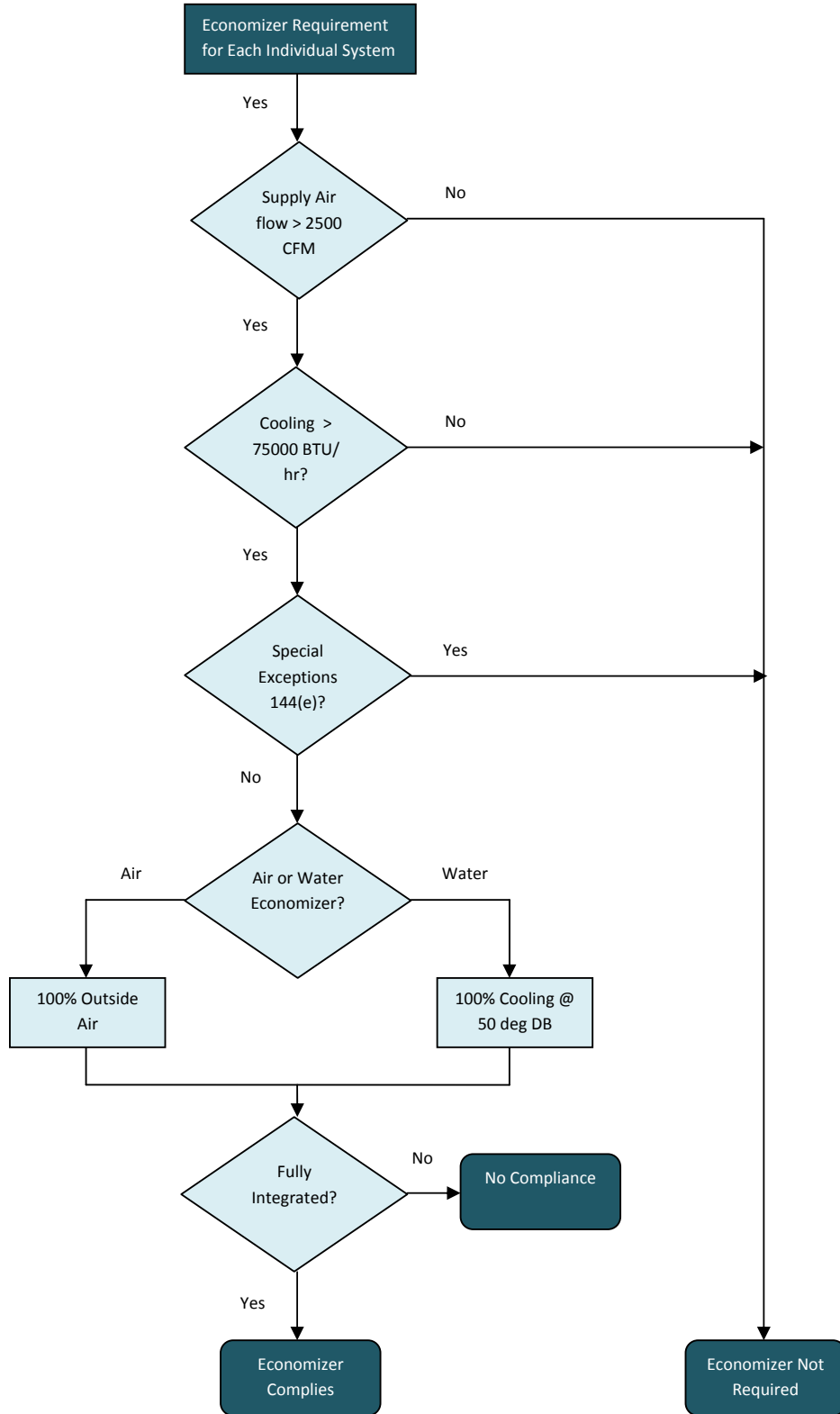

Source: Figure 4-16- Economizer Flowchart in Title 24 2008 Standard

A study of economizers evaluated 22 sites with 52 packaged cooling units. Only 44 percent of the economizers evaluated were still operational after a year or two.

air handling units at an upscale hotel in San Francisco and found none of the six economizers functioned properly.⁴ The issues identified include:

Air Handling Unit	Problems Identified
Lobby	Swapped return & mixed air temperature sensors
Public Corridor	Supply air controller
Lounge/ Atrium	Damper system stuck fully open
South Lounge	Temperature sensor
North Lounge	Temperature sensor
Meeting Rooms	Damper system stuck fully closed

The study goes on to note that five out of the six economizers were experiencing these problems for the entire year they were being monitored, supporting the idea that building operators often overlook these types of performance problems, resulting in wasted energy.

Another study of economizers installed with incentives from the New England Power Services Co. evaluated 22 sites with 52 packaged cooling units.⁵ Only 44 percent of the economizers evaluated were still operational after a year or two. Anecdotal evidence from consultants, mechanical contractors, and commissioning agents suggests that typical failure rates may even be higher.⁶ When the experts were asked to give their impressions of what percentage of economizers work properly, the typical response was that 25 percent or fewer are doing the job.

In general, properly functioning economizers save the most energy when the weather is cool and utility loads are low, and they save no energy during extremely hot weather when utility loads are high (**Figure 4, page after next**). However, economizers that fail in the fully open position contribute to extremely high peak loads. For example, in the Bakersfield building simulated in Figure 3 (**next page**), an economizer stuck in the fully open position would add 84 percent to the summer peak load, assuming the building has ample cooling capacity to achieve that increase. With studies showing a 43% failure rate for mechanical damper operations, there is no doubt dampers that fail in the fully open position have an extreme impact on peak load.⁷ Effective programs designed to prevent this failure mode are likely to reduce peak demand and improve load factors.

The Pathology of Economizer Failure

It is ironic that the very thing an economizer takes advantage of—fresh outdoor air—is often a leading contributor to its failure. As air flows over the outside-air

HOW MUCH ENERGY CAN ECONOMIZERS SAVE (OR WASTE)?

How much energy a malfunctioning economizer wastes depends on both the climate it operates in and the way it has failed. To estimate how much energy a properly functioning economizer might save (and how much a malfunctioning one might waste), we ran a computer simulation of a typical 10,000-square-foot office building placed in four U.S. cities with disparate climates (see Figure 3). We assumed this building would feature a packaged rooftop unit equipped with an economizer and a drybulb temperature controller. Savings attributed to properly functioning economizers in these cities ranged from 2 to 9 percent of total building energy consumption, the most effective performance being in San Diego’s mild climate.

This simulation also suggests that in hot and humid climates, economizers are of questionable value. When they work well,

they provide small energy savings at best. (In hot and humid Tampa, Florida, it would save just 2 percent of total building electricity when working properly.) At worst, when they get stuck in a fully open position, they waste prodigious amounts of energy. (In Tampa, if the damper is stuck in the fully open position, the economizer could consume 52 percent more energy [as a result of cooling a much larger volume of hot, humid outdoor air] than a building with no economizer at all, and would do so during the peak energy billing periods.)

In actual operation, it is unlikely (though possible) that a stuck economizer would waste quite as much energy as our simulation suggests. More likely, cooling and heating in the building would be insufficient to keep occupants comfortable all year long with the damper fully open, and eventually the open damper would be discovered and closed.

Figure 3: How much energy do economizers save?

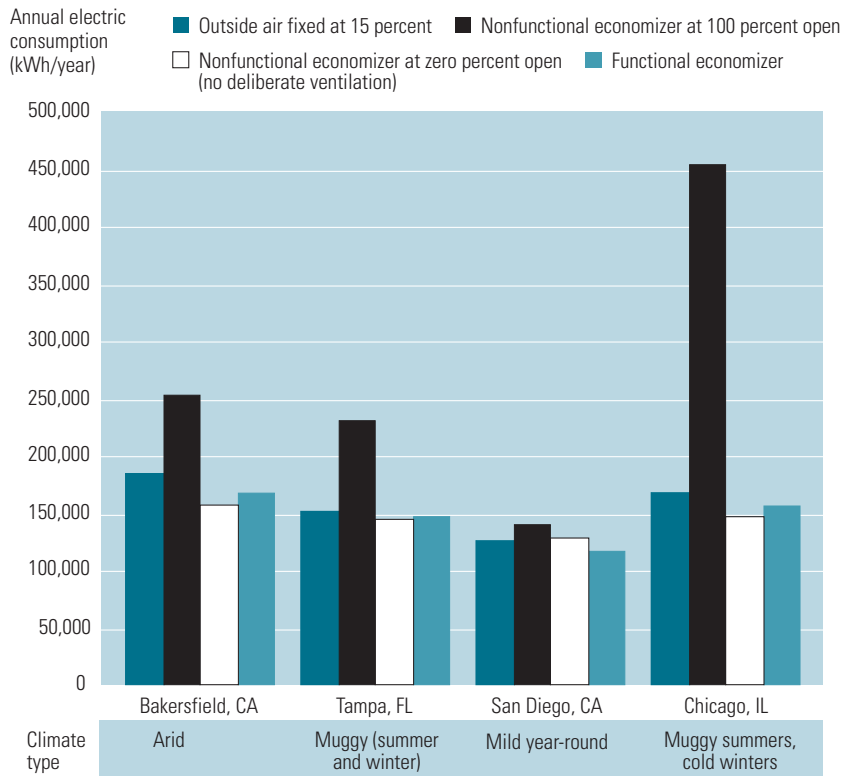

Source: Financial Times Energy

Figure 4: Economizers are valley deepeners

In the lingo of utility planners, load management devices that reduce energy consumption during peak periods are called *peak shavers* (A). Devices, such as economizers, that save energy during mid- and off-peak periods are called *valley deepeners* (B).

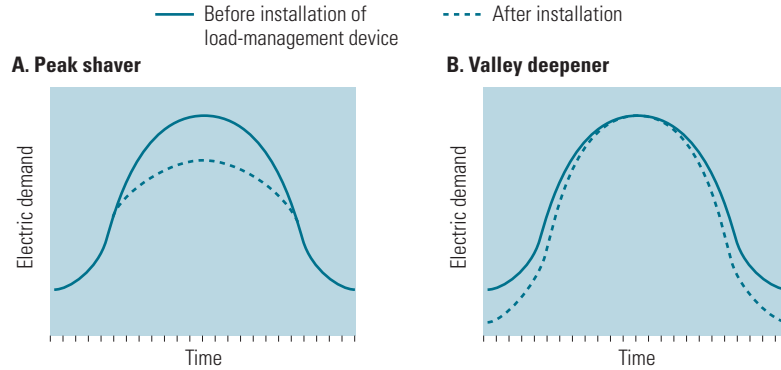

Source: Financial Times Energy

damper and into the building, dirt and moisture accumulate on the damper and its linkages. Unless they are regularly cleaned and lubricated, these components can eventually corrode and lock up. Harsh climates, such as those near the ocean, accelerate the deterioration of most dampers. Sometimes simple wear and tear from proper economizer operation causes components to deteriorate and fail. But failure of individual components is not the cause for all economizer failures. Sometimes each component works fine, but the way components have been installed or are controlled is incorrect, leading to ineffective performance.

In a 2006 study performed for the American Council for an Energy Efficient Economy (ACEEE), it was found that 80% of economizers that were working improperly had more than one problem.⁸

Component Failures

Here are some examples of component failures caused by climatic conditions and simple wear and tear:

- *Jammed outside-air damper.* When an outside-air damper corrodes to the point that it freezes in place (see **Figure 5, next page**), the amount of outside air brought into the building can no longer be varied. Salt air near the ocean is the most common source of this type of corrosion. At other times, dampers may be subjected to industrial corrosion: for example, pollution from automobiles or nearby manufacturing operations, or fuel residue from airports.

Figure 5: Corroded damper

Corrosive salt air is just one reason dampers corrode and freeze in a fixed position. When this happens, the amount of outside air brought into the building can no longer be varied.



Source: Financial Times Energy

Aluminum and galvanized-steel dampers are more susceptible to corrosion than stainless-steel dampers.

Building owners and operating staff are often surprised to learn how quickly a brand-new economizer can deteriorate under harsh conditions. For example, two brand-new, packaged cooling units were installed to cool a classroom facility on the Monterey Peninsula, south of San Francisco. During an energy audit less than one year after those units were installed, the building engineer was amazed to learn that the outside dampers on both units had already jammed. The audit team opened the cabinet on each unit so that the damper was accessible, and then changed the control settings in an effort to make the damper move. In both instances, the actuator did its job and attempted to move the damper, but the dampers were stuck in place and did not yield to pressure from the actuator. Because the equipment was relatively new, it did not take much effort to break the dampers free in order to restore the range of motion, and then lubricate the areas that had frozen up.⁹

- *Jammed, broken, and disconnected linkage.* Sometimes the linkage between an actuator and damper jams (or breaks completely) because of dirt and corrosion, or because the actuator is pushing in vain against a frozen damper (see **Figure 6, next page**). Other times, a maintenance worker intentionally disconnects such a linkage to “correct” improper economizer operation or to provide

Building owners and operating staff are often surprised to learn how quickly a brand new economizer can deteriorate under harsh conditions.

Figure 6: Disconnected corroded linkage

If the linkage between actuator and damper is frozen in position, broken, or disconnected (intentionally or otherwise), the damper will not move.



Source: Financial Times Energy

a quick fix for a comfort problem. Without a firm mechanical connection between the actuator and the damper, the damper will not move.

- *Nonfunctioning actuator.* An actuator is powered either by electricity or compressed air. If there is an interruption in this power source, the damper position will not change, regardless of what the control system is commanding it to do. Common problems include pneumatic tubing that becomes disconnected and damper motors that burn out. At other times, the actuator may loosen from its mounting position, making it difficult or impossible to transfer torque to the damper.

REPAIR CASE STUDY: SAN DIEGO GAS & ELECTRIC

In the early 1990s, San Diego Gas & Electric administered an economizer-repair demand-side management (DSM) program. SDG&E sent a contractor out to repair nonfunctioning economizers free of charge to the customer. The only requirement was that the customer agree to pay for the contractor to come back 12 months later to perform preventative maintenance on the system. Unfortunately the results weren't always successful. The main problem cited was that most of the contractors focused on maintaining individual components, which made some economizers with obvious problems work, but did not help others that had systemic problems, such as an improper sensor location or an undersized exhaust system.

Overall, however, the program was popular with contractors and clients alike. Because contractors were able to offer these free services directly to building owners, it gave them an effective way to provide service to new clients, which often led to additional service work on the rest of the HVAC system. Many building operators didn't even know that their building had an economizer, much less how to maintain it, so they were grateful for the increased awareness. From a market transformation standpoint, this program raised awareness of the importance of maintaining economizers and probably motivated many contractors and building engineers to take a more rigorous approach to maintaining their systems.¹⁰

- *Malfunctioning outside-air temperature sensor.* A malfunctioning outside-air sensor (or a functioning one installed in the wrong location) will provide erroneous temperature readings. Without an accurate measurement of this essential variable, an economizer system will not open and close the outside-air damper at the appropriate times.

Sensors sometimes fall out of calibration or fail completely because of lack of maintenance or just plain old age. In particular, older-technology enthalpy sensors (which use either a plastic film or thin filament that changes dimension in response to humidity) have high failure rates. They usually fail because the material breaks, leading to erroneous measurements. Modern enthalpy sensors use solid-state electronics and are much more reliable. At other times, the problem with an outdoor-air sensor results from its location.

Recently, the engineer for a San Diego high-rise office building could not understand why his chillers were operating first thing in the morning when the HVAC system was turned on. Even on the coolest mornings, shortly after the fan system began operating, a chiller would kick in to cool the building when it seemed it should have been cooled with outside air only. The outside-air temperature sensor was spot-checked with a handheld thermometer and replaced, even though it appeared to be accurate. It was re-installed on the outside-air damper housing on the exterior of the building, with the sensor wiring passing through the louver into the building.

Eventually, investigators learned that the location of the sensor was causing the mysterious chiller operation. Overnight, buoyant warm air would rise through elevator shafts and stairwells, ultimately flowing outward through the outside-air damper on the building's top floor. Enough of this warm air was flowing out through the damper to warm the temperature sensor, which was measuring a temperature of 70 to 75 degrees when the fan system was turned off, regardless of the actual outdoor temperature.

In the morning, the economizer controller would determine that the outside air was too warm to cool the building, and, as a result, the chiller would kick in. After a period of normal fan operation, the sensor would cool down and measure outdoor temperature correctly, allowing the economizer to operate

Sometimes the linkage between an actuator and damper jams (or breaks completely) because of dirt and corrosion, or because the actuator is pushing in vain against a frozen damper.

Sensors sometimes fall out of calibration or fail completely because of lack of maintenance or just plain old age.

properly. Relocating the sensor away from the off-hours wash of warm air corrected the problem.

System Failures

Trickier to diagnose than a component failure is a system failure, which may be an improper control setting or an improperly controlled exhaust fan. Here are some examples:

- *Improper setting for high-limit temperature.* A basic economizer controller includes a dial used to define the temperature below which the outside-air damper can be fully opened. If this is set too low, the economizer will operate less often than it could, leading to higher refrigerated-cooling costs. If the dial is set too high, refrigerated-cooling costs will increase during warm weather because of higher ventilation rates, and comfort may be compromised if this extra load exceeds available cooling capacity.
- *Improper setting for lockout temperature.* An economizer controller has an adjustable lockout setting for those times (for example, the dead of winter in Lake Tahoe) when outdoor air might work wonderfully for cooling, but cooling is not needed. When the temperature is lower than the lockout setting, the economizer damper moves to its minimum position in order to reduce the heating load. If this setting is too low or too high, heating and cooling energy use can increase. Worse yet, in the case of chilled water cooling systems, the cooling coil can freeze and rupture from having cold winter air blow over it.
- *Improper control of building pressure.* For an economizer to work effectively, a nearly equal amount of air must be exhausted from the building as is taken in. Slightly more supply air is usually taken in so that the building will be somewhat pressurized. If the return or exhaust fan doesn't keep up with the supply delivery rate, the building will become excessively pressurized, and the air will seek other routes out. In extreme cases, air may be heard to whistle as it breezes through the stairwells, and the front doors may be hard to close. When this happens, less outside air is brought into the building because of the higher pressure (sort of like the increasing effort of inflating a balloon as it gets bigger), and mechanical cooling may be needed to supplement the reduced flow of outside air.

In the face of the many ways economizers can fail, it may seem like an overwhelming task to design them to operate successfully. Yet most problems can be avoided by specifying economizers with higher-quality components and by commissioning (and periodically recommissioning) them so malfunctions can be readily identified and resolved.

How to Specify Economizers to Prevent Component Failures

To increase the longevity and reliability of economizers, consider including the following features in their specifications:

- *Stainless-steel dampers.* Such dampers resist corrosion much better than the galvanized-steel and aluminum dampers typically used in economizers. Though stainless-steel dampers cost about twice as much as galvanized-steel dampers, they are cheaper than the total cost (including labor) of removing and replacing a failed damper. Unless a building is near sources of marine or industrial corrosion, this extra cost may not be justified. Other features that can improve operation of outside-air dampers include internal linkages (to protect the connections between individual damper blades within the damper frame) and bearings—either ball bearings or nylon bushings—that facilitate smooth rotation of the damper blades. Look for non-metallic gears (nylon, etc.) that are less prone to jam but may be less durable over time than metal linkages.

A facility located on the beach in Ventura County, California, learned the hard way about the corrosive resistance of stainless-steel dampers. The building was constructed without any refrigerated cooling system; it relied entirely on economizers for cooling. Less than two years after the building was first occupied, however, that cooling system was in complete disarray. Not only was the outside-air damper corroded and stuck in an open position, much of the supply-air ductwork was heavily rusted inside and the building's occupants were being showered with fine particles of rust. Also, the building's boilers had inadequate capacity to warm the large volume of outside air the stuck-open dampers let in during the winter, which made the building uncomfortable on cold days. The damper was beyond repair and was replaced with a stainless-steel model. In addition, the rusted ductwork had to be replaced at the same time with expensive stainless-steel ducts. The economizer has been working with few problems since these changes were made.

For an economizer to work effectively, a nearly equal amount of air must be exhausted from the building as is taken in.

Most problems can be avoided by specifying economizers with higher-quality components and by commissioning (and periodically recommissioning) them so malfunctions can be readily identified and resolved.

Although stainless-steel dampers cost about twice as much as galvanized-steel dampers, they are cheaper than the total cost (including labor) of removing and replacing a failed damper.

- *Direct-drive actuators.* Typically, the actuator (which provides the force to move the damper) is connected to the damper by metal linkage, and in many cases the linkage is the Achilles' heel of an otherwise robust system. An economizer with a freely moving outside-air damper and a powerful actuator will still not work if the linkage doesn't function, and over time, these linkages have a tendency to corrode, weaken, or loosen, seriously impairing their ability to transfer torque from the actuator to the damper. A direct-drive actuator has fewer moving parts between actuator and damper, and therefore fewer parts that can fail. In addition, a direct-drive actuator is usually easier to install than a linked actuator, leading to a reduction in installation time in most cases.

Although one manufacturer dominated the direct-drive actuator market for many years, well-known control system manufacturers have started to get in on the action, leading to a more competitive market for these devices (see **Figure 7**). This increased competition has lessened the price gap between direct-drive actuators and the typical linked type to the extent that, in many cases, direct-drive models cost the same or less than their linked counterparts, and, as a

Figure 7: Direct-drive actuator

Actuators that directly drive a damper (without the use of failure-prone linkages) provide greater reliability.



result, direct-drive actuators are now standard equipment on an increasing number of packaged cooling units. Depending on the manufacturer and size of equipment, you may already be getting these reliable damper motors with your economizer.

- *Return or exhaust fans.* For an economizer to work at all, some means for exhausting air from the building in concert with economizer operation must be provided. If a return or exhaust fan is not provided to draw air out of the building through the return ducts, this excess air will seek the path of least resistance out of the building—usually through large, unobstructed openings such as doors, stairwells, and elevator shafts.

Most packaged cooling units with a factory economizer come with an appropriately sized exhaust fan that runs whenever the economizer is active (**Figure 8**) or a barometric or “gravity” damper (**Figure 9, next page**) can be provided to allow excess air to escape from the building during economizer operation. Most built-up HVAC systems use either a general exhaust fan or a return fan (**Figure 10, next page**) to draw air through a ducted return system.

- *Type of control strategy.* The type and location of the building largely determine what type of economizer setup will work best. In dry climates, a simple drybulb control strategy (which responds to temperature only) can provide good performance and comfort. In more humid climates, an enthalpy control strategy (which responds to both temperature and humidity) is generally used to prevent bringing cool but clammy air into a building. In buildings where

A direct-drive actuator has fewer moving parts between actuator and damper, and therefore fewer parts that can fail.

Figure 8: Exhaust fan

The exhaust fan is energized whenever the outside-air damper is fully open in order to remove excess air from the building.

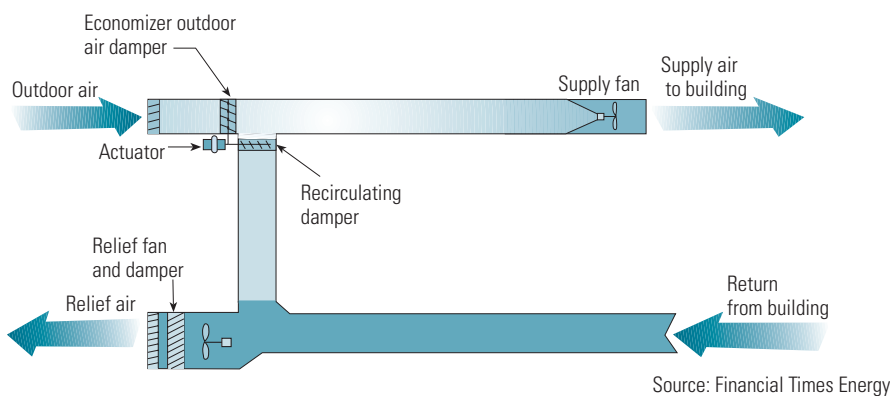

Most packaged cooling units with a factory economizer come with an appropriately sized exhaust fan that runs whenever the economizer is active.

return-air conditions vary widely over the year (perhaps because occupancy varies or because air is distributed by a variable air-volume system), differential control, either drybulb- or enthalpy-based, may be advantageous. Controllers that follow this strategy measure both the outside-air and return-air conditions, and select the cooler or drier airstream to minimize the use of mechanical cooling.

- *Type and location of the outside-air sensor.* For an economizer to work well, it must be able to accurately sense the temperature (or enthalpy) of the outside air. To do this, the sensor needs to be accurate, and it must be installed so it is shielded from direct sun and wind.

Figure 9: Barometric damper

This simple barometric damper is automatically pushed open when the building is in economizer mode and it starts to become pressurized. Alternatively, a motorized damper may be used that is automatically opened when the economizer is activated.

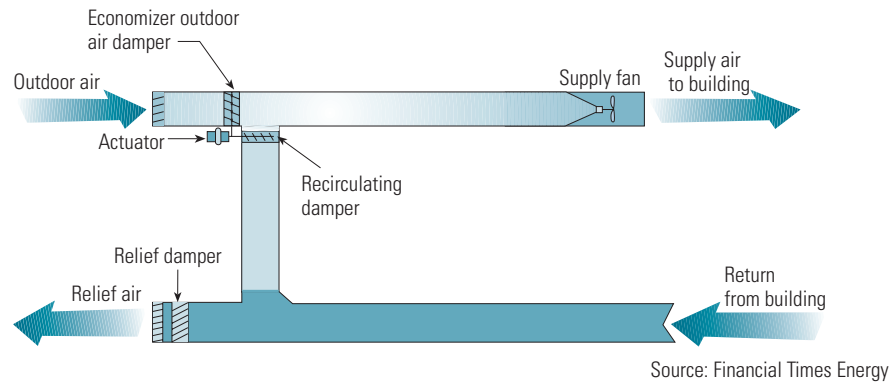
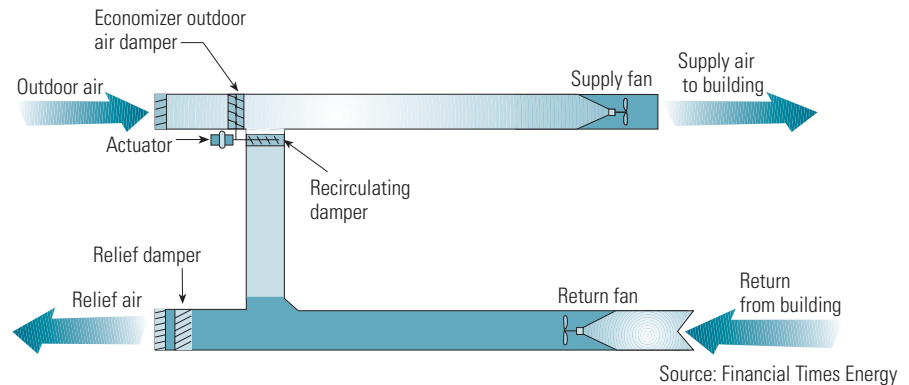

Figure 10: Return fan

The return fan operates in concert with the supply fan to provide slight building pressurization during both economizer and standard operation. Return fans are common in larger buildings that use ducted return air systems.



- *Sensor array.* For larger HVAC systems, installing just one temperature sensor may not be sufficient. This is because hot and cold air may stratify in larger ducts, and a single sensor won't reflect the average air temperature. Installing a temperature-sensing array, which includes multiple temperature sensors and provides an average reading, will provide better performance.
- *Location of outdoor-air intake.* To maximize economizer effectiveness, the outside-air intake should be located away from building exhaust sources (for example, general exhaust, kitchen, and toilet exhaust). And it should not be too close to cooling towers, or hot and humid air will be drawn into the building.
- *Integrated or nonintegrated?* An economizer that cannot work in concert with the mechanical cooling system is referred to as nonintegrated. With such systems, economizer operation is an all-or-nothing proposition: When ambient conditions are cool and dry, the economizer provides all of the necessary cooling, but when things warm up a bit the damper moves to its minimum position and mechanical cooling is engaged. An integrated economizer, on the other hand, can use 100 percent outside air to provide as much cooling as possible and then use mechanical cooling to make up the difference. California's Title 24 requires integrated economizers in most cases, but even if this is not a requirement, an integrated system should be considered, because it provides energy savings during mild weather when a nonintegrated system would provide no savings. In general, integrated economizers save 10 to 20 percent more than nonintegrated economizers throughout California's climate zones.

Integrated economizer systems have some special requirements when used on direct expansion (DX) systems because of the potentially minute cooling loads that may be imposed on the mechanical cooling system. Hot gas bypass or multiple compressors are refrigeration system features that are often specified so that light cooling loads can be served without risk of freezing of the compressor.

Not all of these options are available for all economizers. In general, the larger the economizer, the greater the availability of options. For example, the manufacturer of a three-ton packaged unit may offer very few options—perhaps a choice between, say, the stock temperature-based economizer and a fixed outside-air opening. At the other extreme, a large, built-up air-handling system affords the

In more humid climates, an enthalpy control strategy (which responds to both temperature and humidity) is generally used to prevent bringing cool but clammy air into a building.

To maximize economizer effectiveness, the outside-air intake should be located away from building exhaust sources (for example, general exhaust, kitchen, and toilet exhaust).

specifying engineer the opportunity to call out both the materials and sequences of operation. In general, you don't get many choices on economizer components until about a 15-ton threshold.

Even though a desired economizer feature is available, that does not mean it is cost-effective for a given project. Because the savings produced by economizers vary widely, depending on unit size, operating hours, local climate, and utility rates, designers must estimate economizer cost-effectiveness on a project-by-project basis.

For example, when a 6,000-square-foot retail store was recently designed for a humid coastal climate, the owner's energy consultant put together a wish list of features for the packaged HVAC system. That list included a stainless-steel outside-air damper, direct-drive actuators, and a differential enthalpy controller. A survey of 25-ton packaged units available from the major manufacturers showed that several models offered some, but not all, of the desired features, and prices for these units ranged between \$15,000 and \$20,000.

Thinking it imperative that all the wish-list items be included with the unit, the energy analyst contacted a semicustom manufacturer to get a quote for the owner's HVAC dream machine. The semicustom unit, which featured many nonstandard items in addition to the desired economizer features, was priced at about \$50,000—more than twice the cost of the off-the-shelf alternatives. Although the semicustom unit featured better construction and more-efficient performance, its incremental cost could not be justified.

The design team compromised with an off-the-shelf model that had a stainless-steel damper, the differential control, and some of the other wish-list features. They also commissioned the HVAC system to ensure that it performed according to its design intent. The payback for this investment was less than three years for energy savings alone when compared with the unit that was typically installed in these stores. In addition, after two years of operation, the HVAC maintenance costs for this store are less than half of those for six other similar stores in the same region that use standard equipment.

Making Sure Your Economizer Works Right from the Start and Keeps on Working

Some economizers never stand a chance in life. They are made with all the right components, but they are installed improperly. Even economizers that get off to a good start face an uncertain future. One study that evaluated the longevity of economizers installed as part of new construction concluded that about 50 percent of those installed never worked properly.¹¹

When economizers fail, their poor performance may go unnoticed for a long time. Few symptoms of failure are perceptible to building occupants, because if the economizer isn't working, the chillers and boilers usually just work harder. Even the most seasoned building engineer has probably never received a tenant complaint about the economizer, at least not directly. Only in extreme cases does a malfunctioning economizer result in unacceptable space temperatures or poor indoor air quality. To minimize such problems, an economizer should be commissioned (that is, have its performance tested to make sure it meets the design intent) at start-up and annually thereafter to ensure it continues to function properly. (See the Energy Design Resources brief on “Commissioning” for more information).

There are a variety of ways to commission an economizer. They vary in complexity from simply observing the damper position to installing advanced monitoring tools. Here are a few of the most common test methods:

- *Observe damper position.* Stand next to the outside-air damper with a hand-held thermometer, and compare the damper position with the lockout and high-limit settings. For example, if the lockout setting for the system is set for 50°F, the high-limit temperature is set for 65°F, and you measure the outdoor temperature to be 45°F, the damper should be set at its minimum position so that only the amount of outside air necessary for proper ventilation is admitted. If your observed results are not consistent with the settings on the economizer controller, either the controls are malfunctioning or the damper is stuck. For the same reason that a broken clock tells the right time twice a day, it is impossible to know from a single observation whether a damper is functioning properly or just happens to be frozen in a position that is momentarily consistent with the controls. For this test to be effective, it must be repeated under a range of outside-air conditions.

Because the savings produced by economizers vary widely, depending on unit size, operating hours, local climate, and utility rates, designers must estimate economizer cost-effectiveness on a project-by-project basis.

When economizers fail, their poor performance may go unnoticed for a long time.

- *Fool the economizer controls.* For drybulb economizers, wait for a cool day when the economizer damper is open, and then place both of your hands over the outdoor temperature sensor to warm it up (or use an electric hair dryer if an electrical outlet is close by). When the measured temperature exceeds the high limit setting, the damper should move to its minimum position. If your economizer has enthalpy controls, lightly spraying the enthalpy sensor with water from a spray bottle will temporarily raise the humidity of the air, which should trigger a reaction from the system. If the system does not behave according to its control settings, the sensors are inaccurate (or not working completely) or the economizer controller is not working.

If you observe that the damper is attempting to move but isn't getting anywhere, it may be frozen in position or the linkage may be loose. Try the test again while observing damper operation from the inside of the unit by looking through a service door.

Figure 11: By disabling a faulty economizer, workers reduce steam consumption

At a Texas A&M building, a faulty economizer was letting in excessive amounts of outside air during cold weather. Rather than fix it, maintenance workers chose to disable it, after which steam consumption dropped dramatically, from about 3 to about 1.5 MMBtu/h between January 1993 and January 1994.

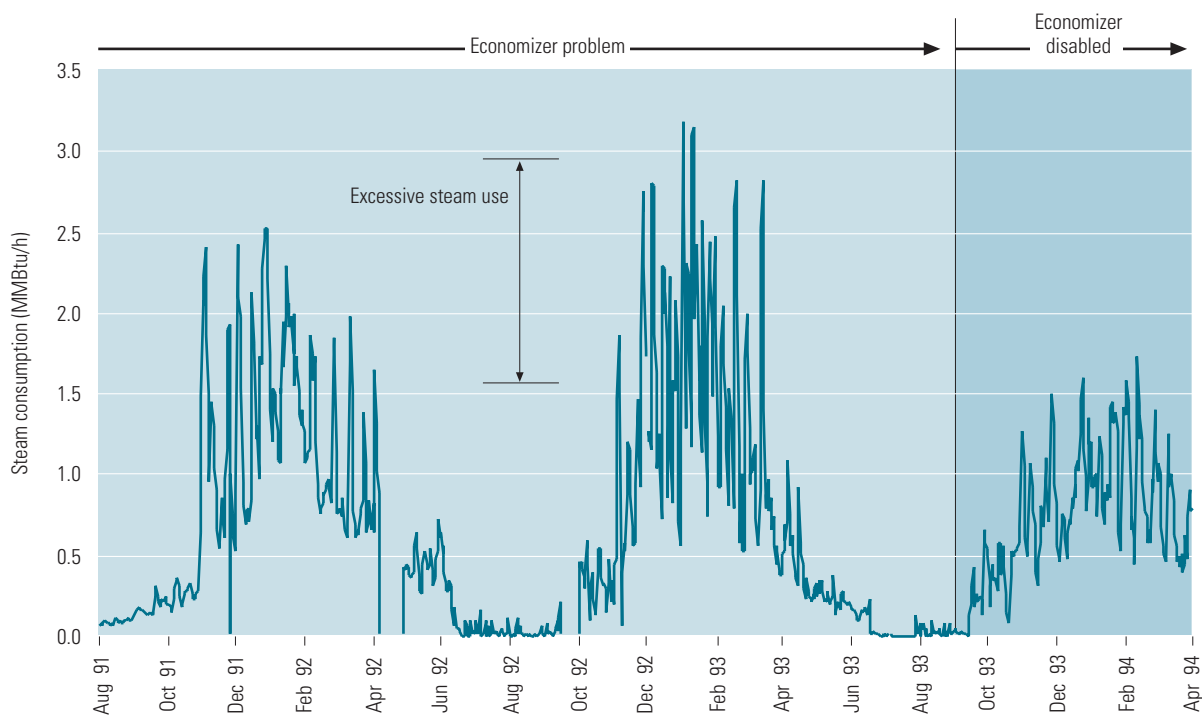

Source: Energy Systems Laboratory, Texas A&M University

- *Look for jumps in heating and cooling energy consumption.* When an economizer sticks open, a lot more heating and cooling energy is needed to condition the excess air the economizer lets in. Often, that increase is large enough to be discerned by analyzing energy consumption records. For example, in 1993, Mingsheng Liu, a researcher with Texas A&M University, spotted a sharp increase in steam consumption at a campus healthcare facility. Subsequent analysis revealed that the economizer was taking in too much outside air during cold weather, costing the facility about \$2,000 a year in additional energy. Liu offered two suggestions to the operating staff: either repair the economizer or disable it during the winter. They chose the second suggestion, even though identifying and fixing the problem with the economizer would probably have produced greater savings. Once the economizer was locked in place, steam consumption dropped dramatically (**Figure 11, previous page**).¹²
- *Install temperature dataloggers.* For a detailed look at how individual economizers operate over time, diagnosticians can install portable devices that measure and log temperature. Typically, these devices are installed in the outside-air, return-air, supply-air, and mixed-air streams for a period of two weeks (**Figure 12**). The collected temperature data may then be downloaded and diagnosed using

There are a variety of ways to commission an economizer. They vary in complexity from simply observing the damper position to installing advanced monitoring tools.

Figure 12: Where to install temperature dataloggers

To diagnose economizer malfunctions on a typical rooftop unit, install temperature dataloggers in these locations: (1) supply air: downstream of the cooling coil as far away from the coil as possible; (2) mixed air: as far downstream from the mixing dampers as possible, but not so close to the cooling coil that the sensor is affected by the coil; (3) return air: upstream of the mixing dampers; and (4) outside air: under the outside-air hood, protected from direct sun.

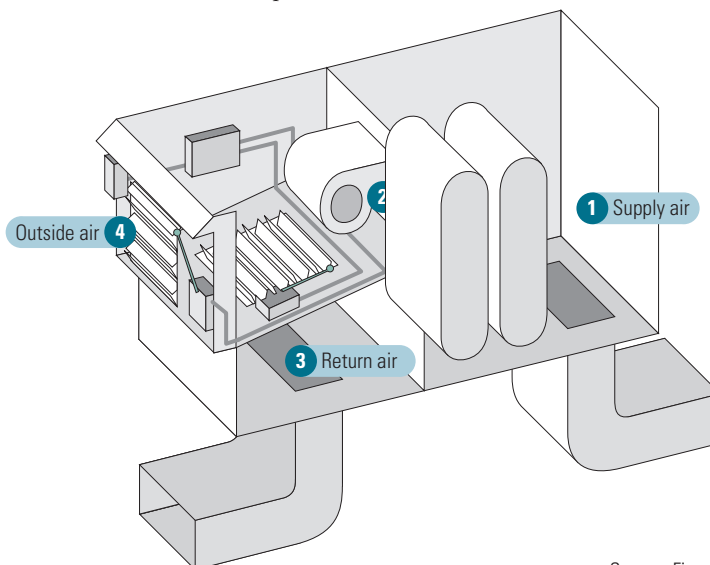

Source: Financial Times Energy

simple spreadsheet software (**Figure 13**). Pacific Gas and Electric Company's Pacific Energy Center maintains a tool lending library (www.pge.com/pec) that provides detailed instructions for using this technique and an Excel™ spreadsheet for analyzing the collected data. This is a relatively inexpensive technique. It costs about \$400 for the four loggers and a few hours to deploy them and to collect and analyze the data. It only takes a few identified economizer faults to pay for the loggers, which can also be used to analyze various other HVAC problems when they're not in the field collecting economizer data.

- *Conduct ongoing diagnostics with an energy management system (EMS).* By monitoring and diagnosing economizer performance on an ongoing basis, malfunctions can be readily identified and repaired before they waste much energy. This can be accomplished by equipping an EMS with the necessary sensors and diagnostic software. Many commercially available software packages are able to accomplish such ongoing diagnoses by analyzing data collected by an EMS. The software can not only identify 20 economizer malfunctions, but it can also learn a building's operating characteristics over time and alert operators to any apparent deviation in energy end-use patterns.

Figure 13:How to analyze data from temperature dataloggers

If an integrated economizer is operating properly (left), the mixed-air and outside-air temperatures should be nearly identical when the outside-air temperature is higher than the supply-air temperature but lower than the return-air temperature. When the outside-air temperature is higher than the return-air temperature, the mixed-air temperature should be slightly higher than the return-air temperature. When the outside-air temperature is below the supply-air temperature, the mixed-air temperature and supply-air temperature should be about the same. The graph on the right presents data from two economizers. One is working properly and follows a pattern similar to that presented in the idealized graph. The other economizer is stuck in a closed or nearly closed position; as a result, the mixed-air temperature is much warmer than the supply-air temperature even when the outdoor air is cooler than the supply air.

Ideal economizer performance

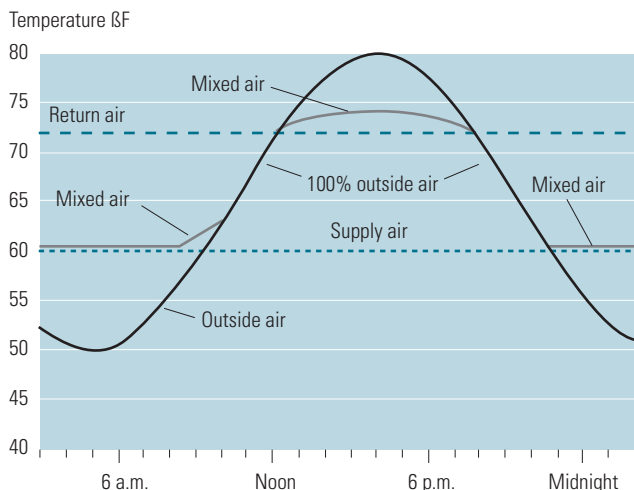

Performance with a good damper and a faulty damper

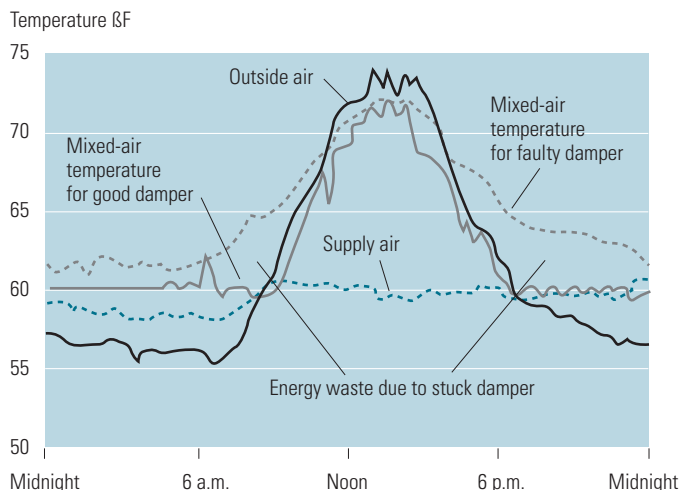

Source: Pacific Energy Center

- *Use the EMS as an extra set of eyes.* The EMS on larger HVAC systems may also be able to provide help in maintaining certain economizer components by reporting misbehavior by dampers or actuators. For example, the EMS could be instructed to fully open and then fully close the outside-air damper each morning prior to HVAC system operation. This daily “exercise” will keep the damper from sitting in one position too long, which may reduce the likelihood of the damper freezing up. Also, actuators that can report their position back to the host computer can be used to determine if the control system is behaving rationally during different weather conditions. Finally, electronic switches can be installed on dampers to keep track of whether they are open, closed, or at some point in between. This can be helpful for diagnosing frozen damper or linkage problems where the actuator pushes in vain to move the damper.
- *Look for supply- and exhaust-air imbalances.* Most commercial HVAC systems are designed to keep building air pressure slightly higher than outdoor air pressure. However, supply and return or exhaust fans often get out of balance, leading to air pressurization problems. Air whistling through stairwells, elevator shafts, and open lobby doors is an indication that more air is being brought into the building than is being removed. This condition may be caused by faulty economizer controls or by inadequate outside relief openings (for example, exhaust damper, toilet exhaust fans, and transfer grills). It is often a problem for buildings designed to deliver only a limited amount (probably 10 to 20 percent of total supply air) of outside air. Economizers that are retrofit on such buildings can’t effectively

For a detailed look at how individual economizers operate over time, diagnosticians can install portable devices that measure and log temperature. It only takes a few identified economizer faults to pay for the loggers, which can also be used to analyze various other HVAC problems when they’re not in the field collecting economizer data.

DIAGNOSTIC SOFTWARE PROVIDER

Contact information is provided here for the Pacific Energy Center, which has created a software program for diagnosing temperature data using simple spreadsheets.

Pacific Energy Center
851 Howard Street
San Francisco, CA 94103
tel 415-973-2277
web www.pge.com/mybusiness/edusafety/training/pec/toolbox/tll/

Electronic switches can be installed on dampers that keep track of whether they are open, closed, or at some point in between. This can be helpful for diagnosing frozen damper or linkage problems where the actuator pushes in vain to move the damper.

bring in 100 percent outside air unless these openings are enlarged and exhaust fans are installed. Because about 40 percent of all economizers were added as a retrofit item, this is a common problem.¹³ At one such building, the outdoor-air intake ductwork was so undersized that the mixing box (where outside air mixes with return air before it is cooled and delivered to the building) collapsed under excessive negative pressure. The maintenance staff at this building responded to this problem by removing the retrofit economizer's actuator, probably the best fix for the situation in this circumstance, because it was unlikely that the system could ever truly operate properly, and it had already caused damage to the rest of the HVAC system.¹⁴

When Not to Use Economizers

Given their temperamental nature, it may not always be in a project's best interest to use an economizer. Though they can provide energy savings when functioning properly, there are circumstances (as outlined in examples throughout this report) that lead to economizer failures more often than not. An economizer may not be a reliable energy efficiency measure under the following new-construction or retrofit circumstances:

- When it is located in an especially corrosive environment (for example, close to the ocean or in a heavily industrial region).
- When it is made from inadequate materials (for example, when upgraded economizer components are not offered, such as on smaller capacity cooling units).
- When it is capable of producing only inconsequential energy savings due to building usage or location (for example, a hot, humid climate or a manufacturing facility that requires constantly low relative humidity).
- When the economizer components will be installed in a way that makes access for regular service difficult.
- When the maintenance department is too understaffed to supply a trained technician to service an economizer system.

In these circumstances, a fixed outside-air opening may be the best answer for long-term reliable operation. For larger, chilled water-based systems, it may be possible to achieve similar energy savings by employing a water-side economizer system. For older buildings, or new buildings that use operable windows, it may be possible to greatly offset the use of mechanical cooling by using natural ventilation strategies.

Conclusion

The old adage “if it’s not worth doing right, it’s not worth doing at all” certainly applies to economizers. In many cases, it is better to forego installing an economizer altogether than to install one that will likely fail due to inferior components, deficient maintenance, or a harsh operating environment. However, doing it right—that is, developing an appropriate design strategy, selecting robust components, commissioning the systems, and diligently performing periodic maintenance—can provide substantial cooling energy savings in many climates.

Part of the challenge of making economizers work is recognizing that even the best design and components will eventually fail if the hands-on testing and maintenance is ignored. Persistent energy savings will only result if all stakeholders “buy in” to the responsibilities of this temperamental-yet-effective system. For this reason, designers should seek to involve building owners and operating staff in the economizer/no economizer decision process and clearly communicate the service requirements of the system and its components to the building owner and operating staff before the building is turned over to them.

Given their temperamental nature, it may not always be in a project’s best interest to use an economizer.

Notes

- 1 Results based on DOE-2 analysis of a typical office building.
- 2 U.S. Energy Information Administration, “2003 Commercial Buildings Characteristics,” from www.eia.doe.gov/emeu/cbecs (downloaded August 12, 2011).
- 3 “2008 Building Energy Efficiency Standards: Non-residential Compliance Manual,” California Energy Commission Publication No. 400-2008-017-CMF-Rev1 (March 2010), pp. 4-60- 4-109.
- 4 Pacific Northwest National Laboratory, “Field Results From Application of the Outdoor Air Economizer Diagnostician for Commissioning and O&M,” from www.buildingsystemsprogram.pnnl.gov/fdd/wbd/publications/pnnl-SA-33002.pdf
- 5 “Commercial/Industrial Persistence Studies, Appendix M: Persistence of Savings from Mechanical System Measures Installed in the Energy Initiative and Design 2000 Programs,” prepared for New England Electrical Systems (NEES) by HEC Inc., 24 Prime Parkway, Natick, MA 01760 (June 1993).
- 6 Craig Hofferber, personal communication (October 9, 2000), CFH Systems, 24712 Rollingwood Road, Lake Forest, CA 92630-3120, tel 949-837-7641.
- 7 “Integrated Design of Small HVAC Systems,” prepared for Public Interest Energy Research (PIER) by Architectural Energy Corporation. 142 Minna Street, San Francisco, CA 94105 (2002).
- 8 American Council for an Energy Efficient Economy. “The Premium Economizer: An Idea Whose Time Has Come,” from www.aceee.org/proceedings-paper/ss06/panel03/paper09 (downloaded April 13, 2011).
- 9 CTG Energetics Inc., 16 Technology Drive, Suite 109, Irvine, CA 92618, tel 949-790-0010, fax 949-790-0020.
- 10 Jesse Sandoval, personal communication (July 30, 1999), Senior Engineer, San Diego Gas & Electric, 8306 Century Park Court, Mail Stop CP4200 Government Marketing, San Diego, CA 92123-1593, tel 619-654-1245.

- 11 Mike Kaplan, personal communication (July 26, 1999), Kaplan Engineering, 623 Atwater Road, Lake Oswego, OR 97034, tel 503-635-5154.
- 12 Mingsheng Liu, John Houchek, Aamer Athar, Agami Reddy, David Claridge, and Jeff Haberl, “Identifying and Implementing Improved Operation and Maintenance Measures in Texas LoanSTAR Buildings,” *Proceedings, American Council for an Energy Efficient Economy (ACEEE) Summer Study on Energy Efficiency in Buildings* (1994), pp. 5.158–5.159.
- 13 U.S. Energy Information Administration [2].
- 14 Fred Gordon, personal communication (April 29, 1999), Pacific Energy Associates Inc., 1920 SE Mulberry Avenue, Portland, OR 97214, tel 503-233-6543, fax 503-233-2831.



**Pacific Gas and
Electric Company™**



A  Sempra Energy utility®



An EDISON INTERNATIONAL® Company



A  Sempra Energy™ company



SMUD
SACRAMENTO MUNICIPAL UTILITY DISTRICT
The Power To Do More.®

Energy Design Resources provides information and design tools to architects, engineers, lighting designers, and building owners and developers. Energy Design Resources is funded by California utility customers and administered by Pacific Gas and Electric Company, Sacramento Municipal Utilities District, San Diego Gas and Electric, Southern California Gas, and Southern California Edison under the auspices of the California Public Utilities Commission. To learn more about Energy Design Resources, please visit our Web site at www.energydesignresources.com.

The first edition of this design brief was prepared in 2003 for Energy Design Resources by Financial Times Energy, Inc., Boulder, Colorado. For this second edition (August 2011), Lincus Incorporated and Architectural Energy Corporation performed an engineering review to update passages affected by recent changes in the California Building Energy Efficiency Standards (Title 24 2008). Editorial coordination and support for the second edition was provided by GeoPraxis Inc.